

Lanzar®

AQMP70BTS

OWNER'S MANUAL Mobile Audio System



- **PLL Synthesizer Stereo Radio**
- **Automatic Memory Storing**
- **USB&SD/MMC Card Interface**
- **Fold Down Detachable Panel**
- **Auxiliary Input Function**
- **Bluetooth Hands-free function & A2DP (Advanced Audio Distribution Profile) Stereo Audio Transmission**
- **Smartphone(Android and IOS system) control**

CONTENTS

Installation	3	SD/MMC operation ..	11
DIN Front-Mount (Method A)	3	Bluetooth operation	12
Installing the unit.....	3	Preparing for operation.....	12
Removing the unit	4	Pairing	13
DIN Rear-Mount (Method B).....	5	Connect.....	13
Using the detachable front panel	6	T-menu	13
Wiring Connection	7	Making an outgoing call.....	14
ISO connection	7	Transfer the call between mobile phone	
Location of keys	8	and the unit.....	14
Basic operation	9	Bluetooth audio (A2DP function).....	14
Switching on/off the unit	9	Remote Control	17
Faceplate release.....	9	Specification	18
Sound adjustment	9	Trouble shooting	19
Loudness	9		
Display.....	9		
Equalization.....	9		
Reset function	9		
Mode selection.....	9		
System setting	9		
Auxiliary input.....	10		
Radio operation	10		
Selecting the frequency band	10		
Selecting a station.....	10		
Automatic memory storing & program			
scanning.....	10		
Scan.....	10		
Station storing	10		
USB play operation	10		
Switching to USB mode.....	10		
Selecting files	10		
Pausing playing	10		
Previewing all files.....	10		
Repeating the same file.....	10		
Playing all files in random	10		
Selecting directory up/down	10		
Selecting tracks	11		
Display ID3 information.....	11		

INSTALLATION

Notes:

- Choose the mounting location where the unit will not interfere with the normal driving function of the driver.
- Before finally installing the unit, connect the wiring temporarily and make sure it is all connected up properly and the unit and the system work properly.
- Use only the parts included with the unit to ensure proper installation. The use of unauthorized parts can cause malfunctions.
- Consult with your nearest dealer if installation requires the drilling of holes or other modifications of the vehicle.
- Install the unit where it does not get in the driver's way and cannot injure the passenger if there is a sudden stop, like an emergency stop.
- If installation angle exceeds 30° from horizontal, the unit might not give its optimum performance.

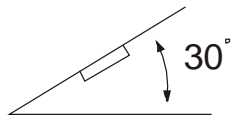

- Avoid installing the unit where it would be subject to high temperature, such as from direct sunlight, or from hot air, from the heater, or where it would be subject to dust, dirt or excessive vibration.

DIN FRONT/REAR-MOUNT

This unit can be properly installed either from "Front" (conventional DIN Front-mount) or "Rear" (DIN Rear-mount installation, utilizing threaded screw holes at the sides of the unit chassis). For details, refer to the following illustrated installation methods.

DIN FRONT-MOUNT (Method A)

Installation Opening

This unit can be installed in any dashboard having an opening as shown below:

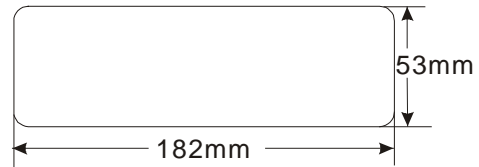

Installing the unit

Be sure you test all connections first, and then follow these steps to install the unit.

1. Make sure the ignition is turned off, and then disconnect the cable from the vehicle battery's negative (-) terminal.
2. Disconnect the wire harness and the antenna.
3. Press the release button on the front panel and remove the control panel (see the steps of "removing the front panel").
4. Lift the top of the outer trim ring then pull it out to remove it.
5. The two supplied keys release tabs inside the unit's sleeve so you can remove it. Insert the keys as far as

INSTALLATION

they will go (with the notches facing up) into the appropriate slots at the middle left and right sides of the unit. Then slide the sleeve off the back of the unit.

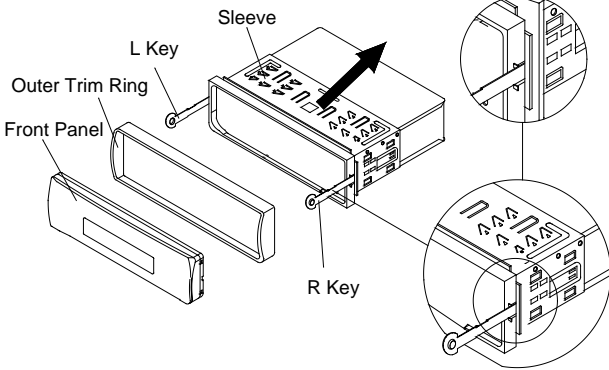

6. Mount the sleeve by inserting the sleeve into the opening of the dashboard and bend open the tabs located around the sleeve with a screwdriver. Not all tabs will be able to make contact, so examine which ones will be most effective. Bending open the appropriate tabs behind the dashboard to secure the sleeve in place.

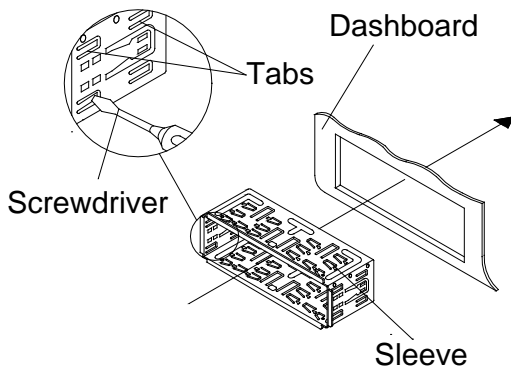

7. Reconnect the wire harness and the antenna and be careful not to pinch any wires or cables.
8. Slide the unit into the sleeve until it locks into place.
9. To further secure the unit, use the supplied metal strap to secure the

back of the unit in place. Use the supplied hardware (Hex Nut (M5mm) and Spring Washer) to attach one end of the strap to the mounting bolt on the back of the unit. If necessary, bend the metal strap to fit your vehicle's mounting area. Then use the supplied hardware (Tapping Screw (5x25mm) and Plain Washer) to attach the other end of metal strap to a solid metal part of the vehicle under the dashboard. This strap also helps ensure proper electrical grounding of the unit.

Note to install the short threading terminal of the mounting bolt to the back of the unit and the other long threading terminal to the dashboard.

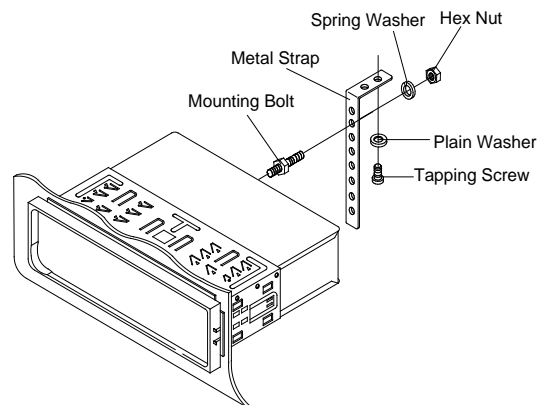

10. Reconnect the cable to the vehicle battery's negative (-) terminal. Then replace the outer trim ring and install the unit's front panel (see the steps of "installing the front panel").

Removing the unit

1. Make sure the ignition is turned off, then disconnect the cable from the vehicle battery's negative (-) terminal.
2. Remove the metal strap attached the back of the unit (if attached).
3. Press the release button to remove the

INSTALLATION

front panel.

4. Lift the top of the outer trim ring then pull it out to remove it.
5. Insert both of the supplied keys into the slots at the middle left and right sides of the unit, then pull the unit out of the dashboard.

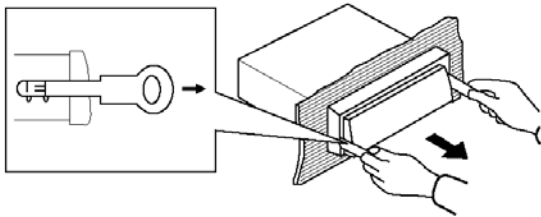

To fasten the unit to the factory radio mounting brackets.

Align the screw holes on the bracket with the screw holes on the unit, and then tighten the screws (5x5mm) on each side.

Note: the outer trim ring, sleeve and the metal strap are not used for method B installation.

DIN REAR-MOUNT (Method B)

If your vehicle is a Nissan, Toyota, follow these mounting instructions.

Use the screw holes marked T (Toyota), N (Nissan) located on both sides of the unit to fasten the unit to the factory radio mounting brackets supplied with your vehicle.

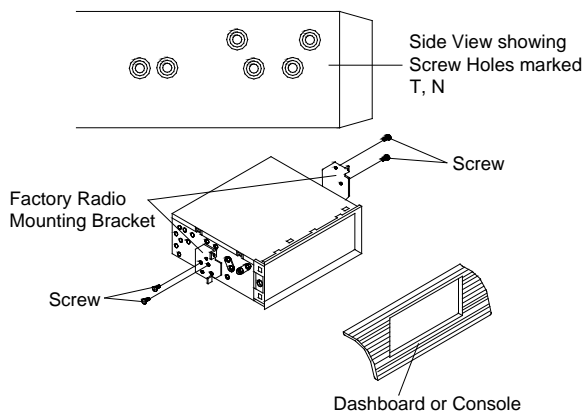

USING THE DETACHABLE FRONT PANEL

REMOVING THE FRONT PANEL

1. Press the release button (▶) on the front panel and pull off the front panel.

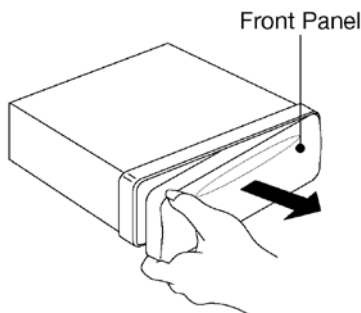
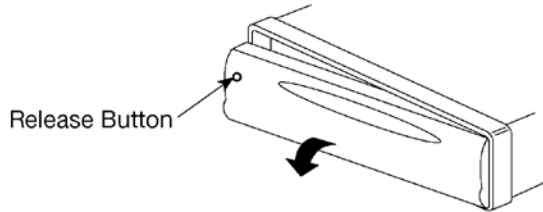

2. Keep front panel into the case.

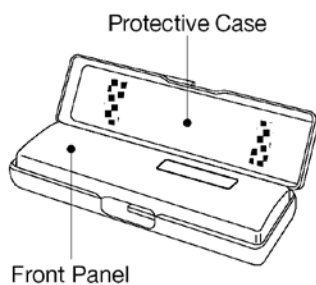

INSTALLING THE FRONT PANEL

To install the front panel, insert the panel into the housing and make sure the panel is properly installed. Otherwise, abnormality occurs on the display or some keys will not function properly.

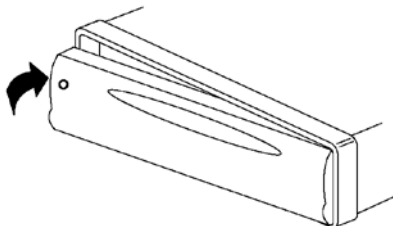

Precautions when handling

1. Do not drop the front panel.
2. Do not put pressure on the display or control buttons when removing or installing the front panel.
3. Do not touch the contacts on the front panel or on the main unit body. It may result in poor electrical contact.
4. If any dirt or foreign substances adhered on the contacts, they can be removed with a clean and dry cloth.
5. Do not expose the front panel to high temperatures or direct sunlight in anywhere.
6. Keep away any volatile agents (e.g. benzene, thinner, or insecticides) from touching the surface of the front panel
7. Do not attempt to disassemble the front panel.

WIRING CONNECTION

ISO CONNECTION

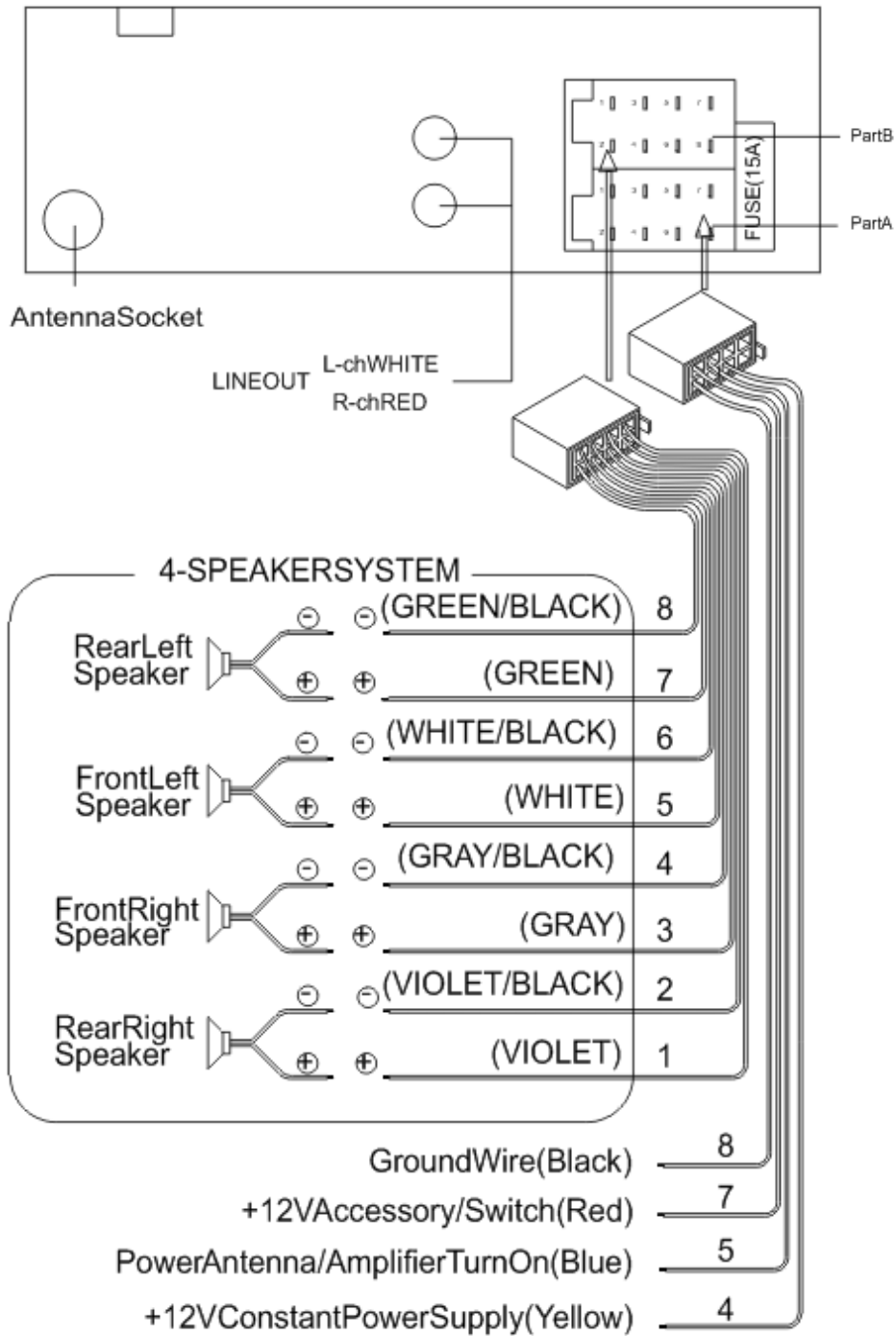

OPERATION

LOCATION OF KEYS

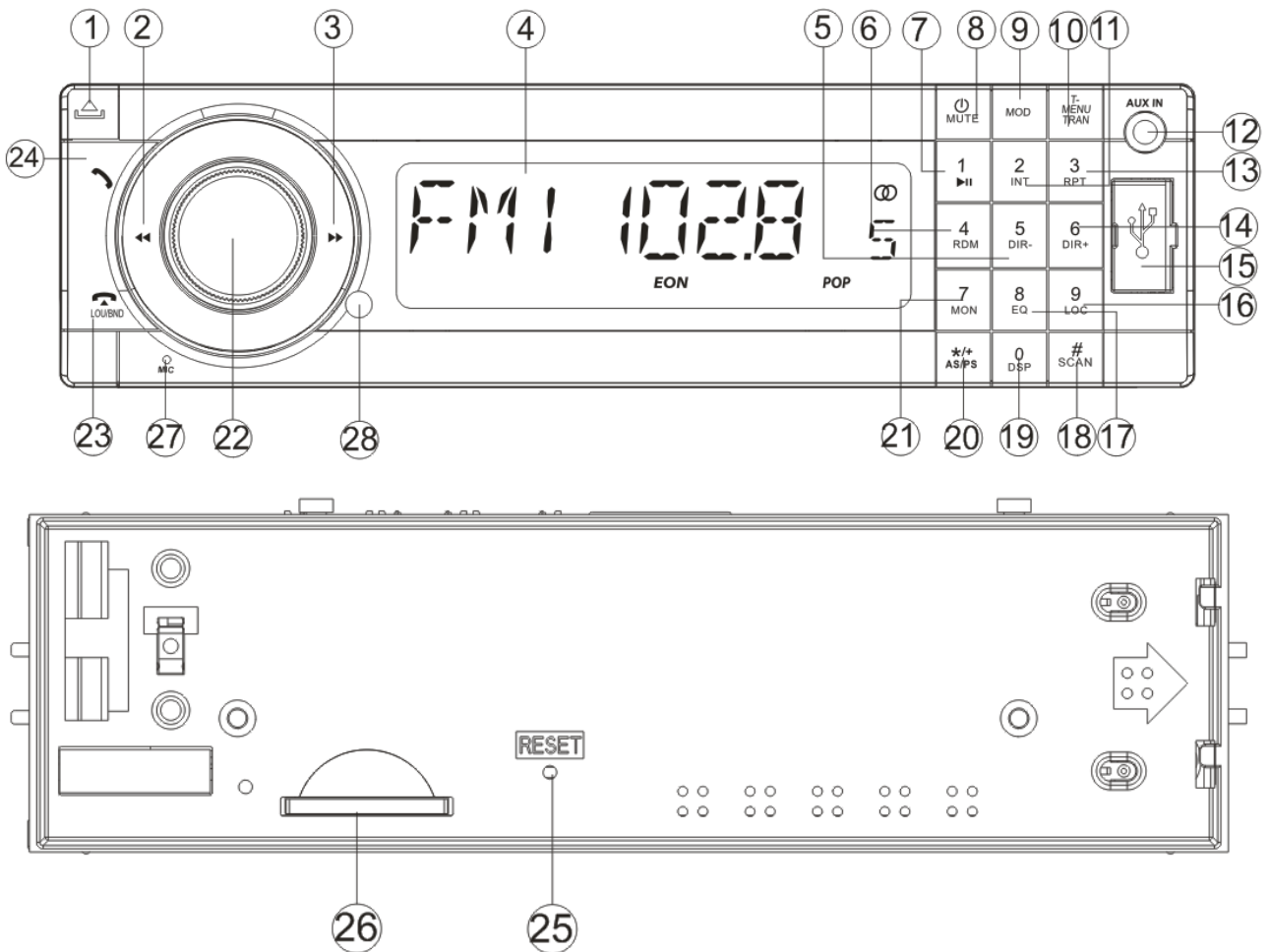

- | | |
|----------------------|---------------------------------|
| 1. (release button) | 17. 8 /EQ |
| 2. | 18. SCAN/# |
| 3. | 19. 0 DSP |
| 4. LCD | 20. */+ / AS/PS |
| 5. 5 DIR- | 21. 7 MON |
| 6. 4 RDM | 22. VOL / SEL/MENU (Audio knob) |
| 7. | 23. (hang up)/LOU/BND |
| 8. MUTE | 24. (pick up) |
| 9. MODE | 25. Reset button |
| 10. T-MENU/TRANS | 26. SD/MMC interface |
| 11. 2 INT | 27. Mic |
| 12. AUX IN | 28. IR |
| 13. 3 RPT | |
| 14. 6 DIR+ | |
| 15. .USB interface | |
| 16. .9 LOC | |

OPERATION

BASIC OPERATION

SWITCHING ON/OFF THE UNIT

Press **⏻** button (8) to turn on the unit.
When the unit is on, press and hold **⏻** button (6) to turn the unit off.

FACEPLATE RELEASE

Press **🔑** button (1) to detach the removable faceplate.

SOUND ADJUSTMENT

Rotate the **SEL** button (22) to adjust the volume. up or down step by step.
Shortly press **MUTE** button (8) will mute the sound, press it again will resume the sound.

LOUDNESS

Press **LOUD** button (23) for several seconds to switch loudness function on, and "LOUD" will appear on the LCD for several seconds. Press it for several seconds again to release this function.

DISPLAY

Press **DSP** button (19) to change display all the unit setting and music information.

RESET FUNCTION

RESET button (25) must be activated with either a ballpoint pen or thin metal object.

The **RESET** button is to be activated for the following reasons:

- Initial installation of the unit when all wiring is completed.
- All the function buttons do not operate.
- Error symbol on the display.

Note: if press **RESET** button (25), the unit can't work yet, please use a cotton swab soaked in isopropyl alcohol to clean the socket on the front panel.

MODE SELECTION

Shortly press **MODE** button (9) to change

the unit working mode: Radio, USB, CARD, IPOD (optional), AUX and BT Audio.

SYSTEM SETTING

Long press the **SEL** button (22) on the front panel to enter SYSTEM SETTING mode.

There are below items to adjust.

P-VOL /ADJ/ BEEP ON/OFF/ LOC ON/OFF ON/ STEREO_MONO/AREA _USA_EUR _ORT_BRZ

Use **SEL** button (22) to select the item you want to change, and use **SEL** button (22) to change the corresponding setting.

1) BEEP ON/OFF:

When the BEEP ON or BEEP OFF is displayed on the LCD, rotate the **SEL** button (22) to switch on/off the BEEP sound

2) P-VOL

P-VOL: The max volume value when you turn on the unit. Such as when you set the P-VOL to 40. If the volume value is small than 40 when you turn off the unit. Next time you turn on the unit. The volume will keep the last volume value. But if the volume value is large than 40 when you turn off the unit. Then next time you turn on the unit. The volume value will back to 40.

3) Radio area setting:

Four areas are insided , that are Europe,USA, Orition,Brasil. Rotate the **SEL** button (22) to set the radio area you wanted.

AUDIO ADVANCED SETTINGS

Short press the **SEL** button (22) on the front panel to enter advanced audio SETTING mode: BESS-TREB-BAL L-R, FAD L-R.

Roate the **SEL** button (22), you can change the Left and right balance and Fader.

Equalization setting

Long press **EQ** button (17) to turn on

OPERATION

equalization function and to select desired audio mode. There are five kinds of mode as below:

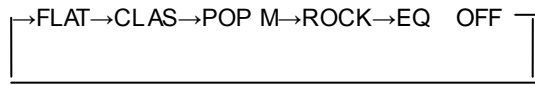

AUXILIARY INPUT

The unit can be connected to a portable audio player through the **AUX IN** jack (12) on the front panel. After finishing the connection, you can press **MODE** button (9) to switch the mode to AUX IN mode.

RADIO OPERATION

SELECTING THE FREQUENCY BAND

At radio mode, press **BAND** button (23) shortly to select the desired band.

The reception band will change in the following order:

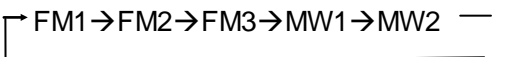

SELECTING STATION

Shortly press **▶▶** / **◀◀** buttons (3/2) to activate automatic seek function. Press for several seconds until “MANUAL.....” appears on the display, the manual tuning mode is selected. If both buttons have not been pressed for several seconds, they will return to seek tuning mode and “AUTO.....” appears on the display.

AUTOMATIC MEMORY STORING & PROGRAM SCANNING

- Automatic memory storing
Press **AS/PS** button (20) for several Seconds, the radio will search from the current frequency and checks the signal strength until one cycle search is finished. And then 18 strongest stations are stored into the corresponding preset number button.
- Program scanning
Press **AS/PS** button (20) shortly to scan preset station. And the corresponding station number P1~P6 will flash on LCD.

SCAN

Press **SCAN** button (18) to enter scan mode, the unit will scan all the frequency rang and keep on each station for several seconds (the corresponding frequency will flash 5 times on LCD).

STATION STORING

Searched a station press preset button (1-6) for several seconds (until 2'nd beeps come out), current station is stored into the number button.

USB PLAY OPERATION SWITCH TO USB MODE

In the front panel of the unit, there is an USB interface (15). You can connect an USB driver through this interface (15).

When you connect an USB driver through the interface, the unit will search the MP3 files or WMA files and start to play automatically.

If in other mode, you can also press **MODE** button (9) to select USB mode.

SELECTING TRACKS

Press **▶▶** / **◀◀** (3/2) will skip to the previous/next file. File number will be showed on display.
Press and hold **▶▶** / **◀◀** (3/2) will fast reverse/forward. File play starts when you release the button.

PAUSING PLAYING

Press **PAU** button (7) to pause, and “Pause” will appear on LCD. Press it again to resume play.

PREVIEWING ALL TRACKS

Press **INT** button (11) to play first several seconds of each file, and “INT” will appear on LCD. Press again to stop scan and listen to file, “INT” will disappear.
Press and hold **INT** button (11) will play first several seconds of each file in the current folder, and “D-INT” will appear,

OPERATION

press it again will exit this mode.

REPEATING THE SAME TRACK

Press **RPT** button (13) will repeat one/ repeat off/ random/random off the music playing.

Press it again will exit this mode.

PLAYING ALL TRACKS IN RANDOM

Press **RDM** button (6), you can random/random off the music playing

ESP FUNCTION (OPTIONAL)

The unit can be shockproof about 70 seconds around for MP3 /WMA.

SELECTING DIRECTORY UP/DOWN

Press **DIR-** button (5) or **DIR+** button (14) to select directory downward or upward. If the USB driver does not contain any directory, there is no function of pressing **DIR-** button (5) or **DIR+** button (14).

DISPLAY ID3 INFORMATION

Press **DSP** button (19) to show the ID3 TAG (title, artist and album).

SUPPORT MP3/WMA DECODING MODE

The main unit supports MP3/WMA (Windows Media Audio) decoding modes as below.

Standard	Bit Rate (kbps)	Supports Mode
MPEG1 Audio Layer 3 (44.1kHz)	32,48,64,96, 128,192,256, 320	Stereo
Windows Media Audio (44.1kHz)	64,96,128,192	Stereo

The USB solution can support:

1. Folder: 500 max.
2. File: 999 max.
3. Depth of folder: 8 layers
4. Size: up to 16GB

USB PLAY OPERATION

In the front panel of the unit, there is an

USB interface (15). You can connect an USB driver through this interface (15). When you connect an USB driver through the interface, the unit will search the MP3 files or WMA files in the USB driver and start to play MP3 files or WMA files automatically.

If in other mode, you can also press **MOD** button (9) to select USB mode.

Note:

- The main unit can only support the standard USB-memory disc which is approved by Microsoft.
- USB MP3 player is not a standard which means different brand name or different models have their own standard. So our product cannot support every MP3 player.
- When connecting an MP3 player and there has normal battery in the player (non rechargeable battery), you should remove the battery from the MP3 player then connect it to the USB interface. Otherwise, it may cause battery burst.

SD/MMC OPERATION

The SD/MMC interface is on the housing of the unit. only release the front panel, you can find it.

When you insert a SD/MMC card in the SD/MMC mode, the unit will search the MP3 files or WMA files in the card and start to play the files automatically. The operation is the same with the MP3 operation described above. If in other mode, you can also press **MOD** button (9) to elect SD/MMC mode.

CAUTION

When there are important files in the USB

OPERATION

device or SD card. Do not connect it to the main unit to play. Because any wrong operation may cause files loss.

BLUETOOTH OPERATION

• PREPAIR FOR BLUETOOTH OPERATION

(i) When use Bluetooth, please make sure the mobile phone supports Bluetooth function.

(ii) For the different kind of mobile phone, Bluetooth emissive power has some difference. To get the best conversation quality, it is commended that the distance between the mobile phone and the unit is within 3m. And please don't put any metal object or any obstacle between the path of the mobile phone and the unit.

• CONNECT

This unit is built-in auto-reconnection function. Every time when you short press  button (24), the unit will auto reconnect with the mobile phone (note: the mobile phone must have been paired with the unit before.).



1) If the mobile phone is out of range, the connection will be lost, when you come back to the unit, reconnection is necessary.

2) When the mobile phone is out of range from the unit, and there is an incoming call, when you come back to the unit, and you want to transfer the audio to the unit, you need to reconnection.

3) When you press  button (1) to release the front panel, the connection will be break off. When you install the front panel, you need to reconnection.

4) If you turn off the mobile phone that has paired with the unit, when you turn on the mobile phone, you need to reconnection.

• T-MENU

When successful paired, shortly press **T-MENU** button (10) on the front panel will enter the telephone menu, keep pressing this button or press /  button (2/3) to change the items in this menu. The items will be displayed in the following sequence: RECELVED / DIALED / MISSED / MANU ANS / TALK.

1) RECELVED: Display the last call you have received (memory 10 numbers).



2) DIALED: Display the last dialed number (memory 10 numbers).

3) MISSED: Display the call you have missed (memory 10 numbers).

4) MANU ANS (manual answer):

You can set Answer mode to manual answer (MANU ANS) mode or Auto Answer (AUTO ANS) mode.

In auto answer mode, when a call coming the Phone Number will appear on LCD. The unit will answer the call automatically.

In **MANU ANS** mode, when a call coming, the Phone Number will appear on LCD. you can press  button (24) to answer the call, or press  button (23) to reject the incoming call.

6) TALK (00~20):

You can setting the bluetooth volume in TALK 00 item. If it is 00, When there is a call coming. the main volume will set to 60 automatically. If

OPERATION

you set TALK to 20. The main volume will set to 100 automatically when a call is coming.



Example:

TALK volume		MAIN volume
00	=	60
01	=	62
02	=	64
.....		
20	=	100

- **MAKING AN OUTGOING CALL**

1) Making an outgoing call from

RECEIVED LIST, DIALED LIST, MISSED LIST, PHONE BOOK(Mobile Phone) and PHONE BOOK(SIM Card) please refer to the **T-MENU** section.

2) Making an outgoing call by inputting the phone number manually. Press  button (24) on the front panel "CALL_" will appear on LCD. Use 0~9, *, # buttons to enter the phone number you want to dial. (Note: shortly press * button will input "*" character, press and hold it will input "+" character). Then press  button (24) again will call the number.

Note: if you input the wrong number, shortly press BND button (23) will clear it. Press and hold **BND** button (23) will clear all numeric.

- **TRANSFER THE CALL BETWEEN MOBILE PHONE AND THE UNIT**

During the talking mode, you can press and hold **TRANSFER (T-MENU)** button (10) to transfer the phone call between the mobile phone and the unit.

Note:

1) If you transfer the call to mobile phone, the mute of the present mode will be released at the same time.

2) When making an outgoing call, it's not possible to transfer if the call is not being answered yet.

- **BLUETOOTH AUDIO (A2DP FUNCTION)**

The unit supports Bluetooth audio function. Before using this function, make sure the BT connection is established from the unit and the mobile phone.

When using the D2DP music playing, you need turn the unit to BT audio mode. You can control it by Mute, Play/Pause, Next/Previous etc. keys on the front panel.

Also you can control the BT audio by your mobile phone.

How To Use the Apps in The Smartphone

Download the Apps "**Radio View**" from the google play or the Apple store, and install it in your smartphone.

Smartphone supports both the android and IOS operation system.

1. click the mobile phone LCD and choose as the follows: "settings" "wireless and networks" —>"bluetooth settings, turn on the bluetooth and try to pair the unit

2. Click  to select "Radio View", and the Apps will be opened.

OPERATION

3. If you first time open the radio view, please tap the Menu key on your smartphone, and choose to connect a device as prompted, then scan for the BT devices.
4. Connect the smartphone and unit BT device named EP-BT.
5. When the BT connecting is established, you are ready to using the Apps and the unit LCD will displaying controlled by smartphone all the times until you shut down the radio view Apps.

87.5MHz ---current radio frequency

 --- previous or next radio station

 --- the 6 radio stations stored after the scanning.

Click , enter into the SETTING interface:

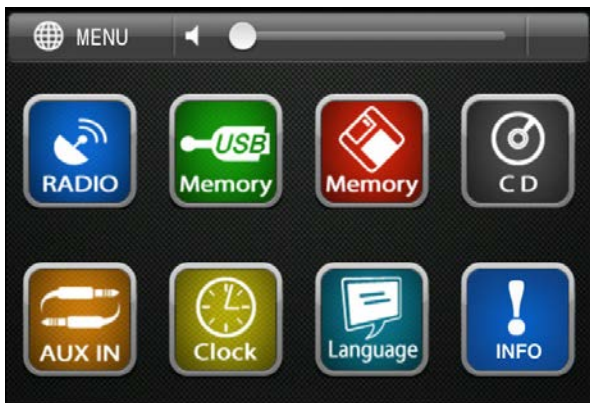

Click , enter into the radio interface:



Click , you can set the EQ:



 --- close the current window

FM1 ---FM and MW band display

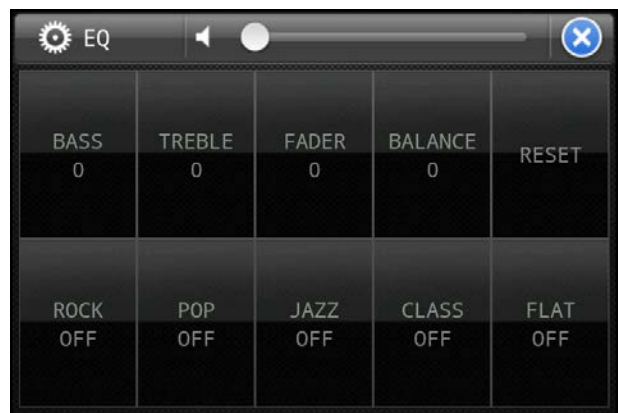

Click , enter into the playing

OPERATION

settings:



Click , enter into the tuner settings:



Click , enter into the tuner settings:



Click , enter into the USB mode:



If no USB, all the icons will be in grey and can't be touch.

FileName 1 --- music file name

in the USB



---Previous or next song



--- the current process status of the playing

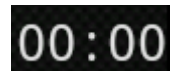

--- Time have already played /

The total time of the song



Click , enter into the SD mode:

OPERATION



If no SD, all the icons will be in grey and can't be touch.

FileName 1---

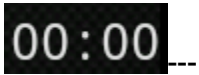

Click , enter into the AUX IN mode:



Click , enter into the Clock interface.:

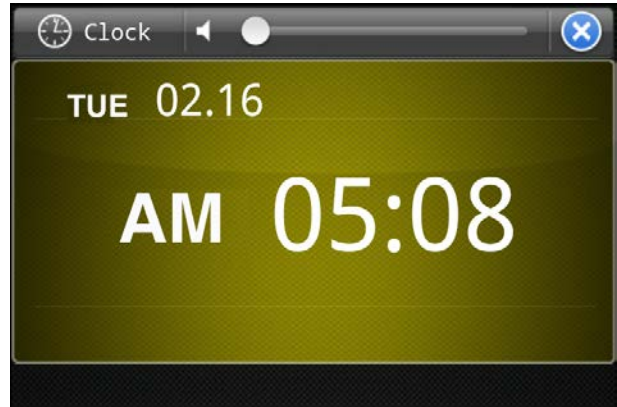

Click , enter into the Bluetooth A2DP interface as follow:



The Magic Key
ONE-T+COOL-T :Song name



:the previous or next song



--- the current process status of the playing

00:24 / **03:51**---

Time have already played / The total time of the song

If no device, such as USB,SD,CD deck found in the unit, the correspond icons on the Apps interface will be in grey and can't be touchable.

REMOTE CONTROL HANDSET(OPTIONAL)

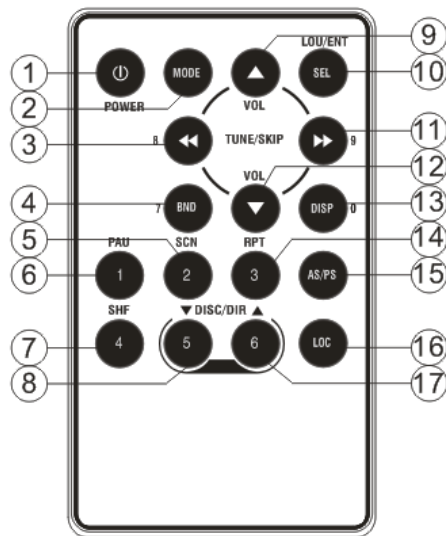

FUNCTION KEY & CONTROL

- | | |
|--|--|
| 11. POWER | Power ON/OFF Button |
| 12. MODE | Mode Button (S, T, U, 7, For MP3/WMA Operation) |
| 13. TUNE/SKIP◀◀ (8) | Tune/SKIP Down Button(V, W, X, 8 For MP3/WMA Operation) |
| 14. 7/BND | Band Select Button(When pressed shortly) |
| 15. SCN | Scanning Button(D, E, F, 2 For MP3/WMA Operation) |
| 16. PAU | Pause Button (A, B, C, 1 For MP3/WMA Operation) |
| 17. SHF | Shuffle Button (J, K, L 4 For MP3/WMA Operation) |
| 18. DIR▼ | DIR▼ Button |
| 19. VOL▲ | Volume Up Button
(Character Select (A, B~8, 9, 0) For MP3/WMA Operation) |
| 20. SEL (LOU/ENT) | Sound Mode Select Button
(Character Shift Right For MP3/WMA Operation)
Loudness Button (When pressed long)
(Enter Button For MP3/WMA Operation) |
| 21. TUNE/SKIP▶▶ (9) | Tune/SKIP Up Button(Y, Z, SPACE, 9 For MP3/WMA Operation) |
| 22. VOL ▼ | Volume Down Button
(Character Select(A, B~8, 9, 0) For MP3/WMA Operation) |
| 23. DSP(0) | Display Button(., -, +, 0 For MP3/WMA Operation) |
| 24. RPT | Repeat Button(G, H, I, 3 For MP3/WMA Operation) |
| 25. AS/PS(D-AUD) | Automatic |
| 26. Memory Storing & Program Scanning Button | (Mode Select Button For MP3/WMA Operation) |
| 27. LOC | Local/Distant Select Button |
| 28. DIR▲ | DIR▼ Button |

SPECIFICATION

GENERAL

Power Supply Requirements	: DC 12 Volts, Negative Ground
Chassis Dimensions	: 178 (W) x 107 (D) x 50 (H)
Tone Controls	
- Bass (at 100 Hz)	: ±10 dB
- Treble (at 10 kHz)	: ±10 dB
Maximum Output Power	: 4x60watts
Current Drain	: 15 Ampere (max.)

RADIO

(U.S.A)

FM

Frequency Coverage	87.5~108 MHz
IF	10.7MHz
Sensitivity (S/N=30dB)	4 μ V
Stereo Separation	>25dB

AM

Frequency Coverage	520~1710 KHz
IF	450 KHz
Sensitivity (S/N=20dB)	36dBuV

TROUBLE SHOOTING

Before going through the checklist, check wiring connection. If any of the problems persist after checklist has been made, consult your nearest service dealer.

Symptom	Cause	Solution
No power.	The car ignition switch is not on.	If the power supply is connected to the car accessory circuits, but the engine is not moving, switch the ignition key to "ACC".
	The fuse is blown.	Replace the fuse.
	Temperature inside the car is too high.	Cool off or until the ambient temperature return to normal.
	Condensation.	Leave the player off for an hour or so, then try again.
No sound.	Volume is in minimum	Adjust volume to a desired level.
	Wiring is not properly connected.	Check wiring connection.
Sound skips.	The installation angle is more than 30 degree.	Adjust the installation angle less than 30 degree.
The operation keys do not work.	The built-in microcomputer is not operating properly due to noise.	Press the RESET button. Front panel is not properly fix into its place.
The radio does not Work. The radio station automatic selection does not work.	The antenna cable is not connected.	Insert the antenna cable firmly.
	The signals are too weak.	Select a station manually.