

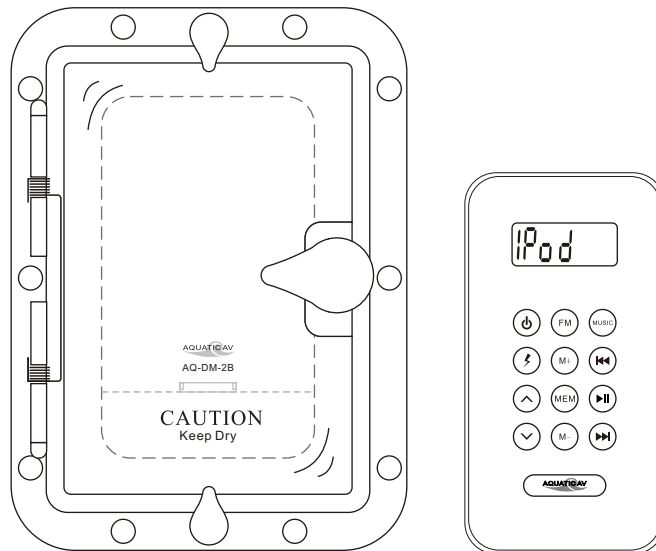

iPod™ + MP3

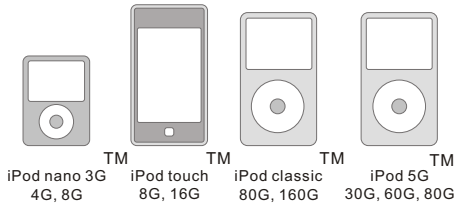

INSTRUCTION MANUAL



**Model AQ-DM-2B**  
**Water/Dust Proof MP3/iPod™ Digital Media Locker™**  
**With**  
**Floating RF LCD Wireless Remote Control**

**Please read this Instruction Manual  
before installation and operation**

## LOCATION OF CONTROLS

### MP3/iPod™ Water/Dust Proof Digital Media Locker™

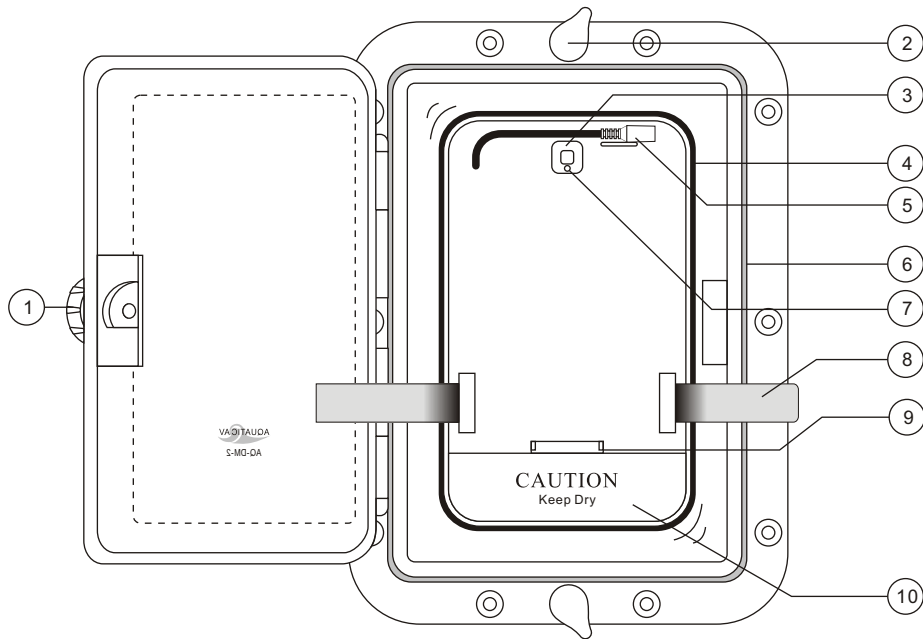

Part	Description
1	Digital Media Locker Knob and Protective Door
2	Auxillary Locker Knobs
3	ON/Off Power Button
4	Water/Dust Protection Inner Gasket
5	3.5mm Aux Input Jack for MP3 Devices
6	Water Retarding and Drainage Groove
7	ON/Off Power LED
8	Security Strap for Digital Media Devices (MP3/iPod™)
9	iPod™ Connector
10	iPod™ Cradle (totally 5 iPod™ Cradle adaptors)

## GETTING STARTED

### CONTENTS:

Please make sure the following items are included.

- a) AQ-DM-2 Digital Media Locker™
- b) Water/Dust Proof RF Wireless Remote Control
- c) Ten (10) Finishing Covers for Stainless Mounting Screws
- d) Five (5) iPod™ Cradles
- e) Ten (10) Stainless Steel Wood Screws
- f) Two (2) CR-2032 Batteries

### INSTALLATION

#### Cable Connection

1. **Plug and Play Connector:** The AQ-DM-2 incorporates a 12 pin "plug and play" connector harness. Owner product application options may require an "optional" connector option. Contact your dealer for details.
2. **FM Radio:** The AQ-DM-2 has U.S. and Euro FM Frequency capability. In both applications, make sure the FM Antenna is fully extended at the highest possible level (Height) for best performance.
3. **RCA Inputs:** The AQ-DM-2 was developed with flexibility to use RCA based Audio Media. The AQ-DM-2 has 1 set of RCA Audio Auxiliary Inputs so you can connect other RCA based devices.

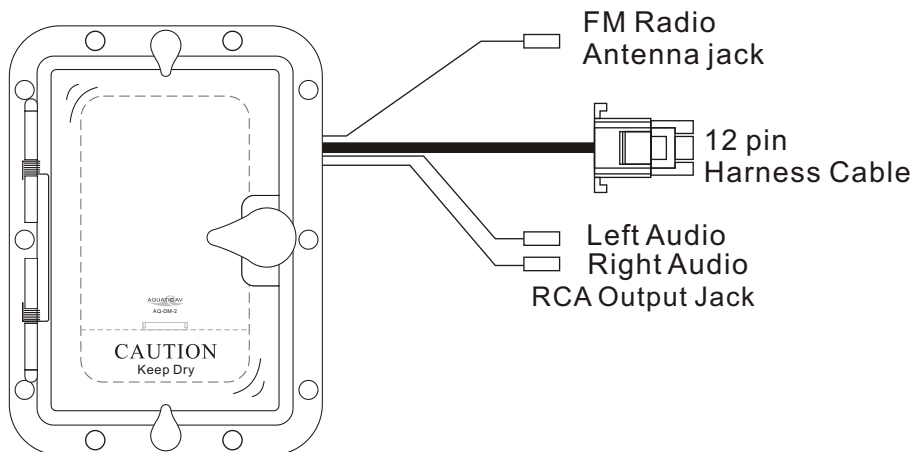

**i** For non-OEM use, wiring harness must be ordered separately  
Part number AQ-UNH-1 or AQ-UNH-2

## LOCATION OF CONTROLS

### RF LCD Wireless Remote Control

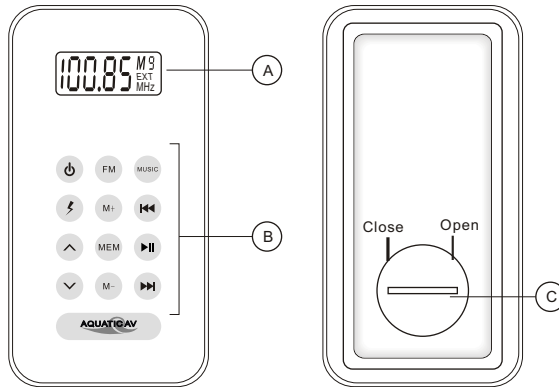

Part	Description
A	Remote Control LCD
B	Remote Control Buttons
C	Battery Door.

Buttons		Music Mode	FM Radio Mode
Power		Press once: Change from Operation mode to Standby mode. Press and hold: Change from Standby mode to Operation mode.	
12V trigger		Press once: Toggle external power Press and hold: No change	Press once: Toggle external power Press and hold: No change
Volume up		Press once: Volume UP 3 decibels Press and hold: Fast volume up	Press once: Volume UP 3 decibels Press and hold: Fast volume up
Volume down		Press once: Volume DOWN 3 decibels Press and hold: Fast volume down	Press once: Volume DOWN 3 decibels Press and hold: Fast volume down
FM Radio		Press once: Change to FM Radio Mode Press and hold: No change	Press once: No change Press and hold: No change
Memory +		Press once: No change to memory Press and hold: No change to memory	Press once: Increase Memory Location Press and hold: No change
Memory		Press once: No change to memory Press and hold: No change to memory	Press once: Toggle to Memory Mode Press and hold: No change
Memory -		Press once: No change to memory Press and hold: No change to memory	Press once: Decrease Memory Location Press and hold: No change
Music		Press once: No change to Ipod/ MP3 Press and hold: No change to Ipod/ MP3	Press once: Toggle to ipod/ Music Mode Press and hold: No change
<b>i</b> Fast Rewind		Press once: Last track Press and hold: Fast Rewind	Press once: -50kHz Press and hold: Scan backward
Pause/ Play		Press once: Toggle Play/Pause Press and hold: Turn iPod™ OFF	Press once: Mute Press and hold: No change
<b>i</b> Fast Forward		Press once: Next track Press and hold: Fast Forward	Press once: +50kHz Press and hold: Scan forward

- i** if your music player is not an iPod,™  
You will only be able to use the volume and power control on the remote Control
- i** In order to prolong remote battery life the LCD will shut off in 10 seconds if no other button is pressed. To turn remote back on press power once and then press the command desired.

## GETTING STARTED

Remove the Water/Dust Proof RF Wireless Remote control from the Digital Media Locker™. Unscrew the waterproof cap on the back of the remote control, place the CR-2032 in the RF Remote control and replace the waterproof cap.



Always ensure to connect and disconnect your media player with dry hands.



Always activate the on-off button when operating the Digital Media Locker™. By doing so, your battery life will be extended.



Important Notes on the Use of Remote Control

The remote control LCD will display " - -" whenever it is turned ON. This display will remain until Radio mode or iPod™ mode is selected. The LCD will also display " - -" if it is out of its 20ft range.

This remote control use state-of-art technology and will inform you if the dock is receiving the command from the remote control. In any case, if the LCD display " - -" again in either mode, this means that your remote control is out of range of reception. Please try the feature again.



### Power ON Button

To activate the Digital Media Locker™, press the on/off button. On will be indicated by a RED LED.

For applications where normal Digital Media Locker™ operation requires an independent 12V battery (Boat, RV), power down the AQ-DM-2 via the RF remote control. This will insure against independent battery drain. Other applications using 12V power converters are compatible with the AQ-DM-2.

### RF Wireless Remote Control Synchronizing

Each Digital Media Locker™ comes with a matching RF Wireless LCD Remote control to maximize wireless performance. For all newly purchased remote controls, you will need to activate/Synchroize those remote controls to the AQ-DM-2 by following the steps below:

- Press and hold the  button (Play/Pause) on the remote control and then press the  Power button simultaneously for 2 seconds. The LCD will display "Pair". 
- Turn on the Digital Media Locker™ by pressing the power button on the AQ-DM-2 within 10 seconds after the remote is paired. (A Red LED light will turn on under the power button to indicate the unit is turned on.)
- Once synchronizing is complete, the LCD will return to the original screen setting.



If you loose your remote control and buy another new remote control, please follow the above to start pairing before normal usage.

## GETTING STARTED

### 12 Pin Harness Cable Connection

Aquatic AV recommends the use of a optional "plug and play" connector for best performance (AQ-UNH-1). This connector is not included.

For detailed information, please call the re-seller. If you choose not to use the "plug and play" option, you can use the wiring schematic below. All open wire connections should be soldered, and protected against Water/Dust for best long term performance.

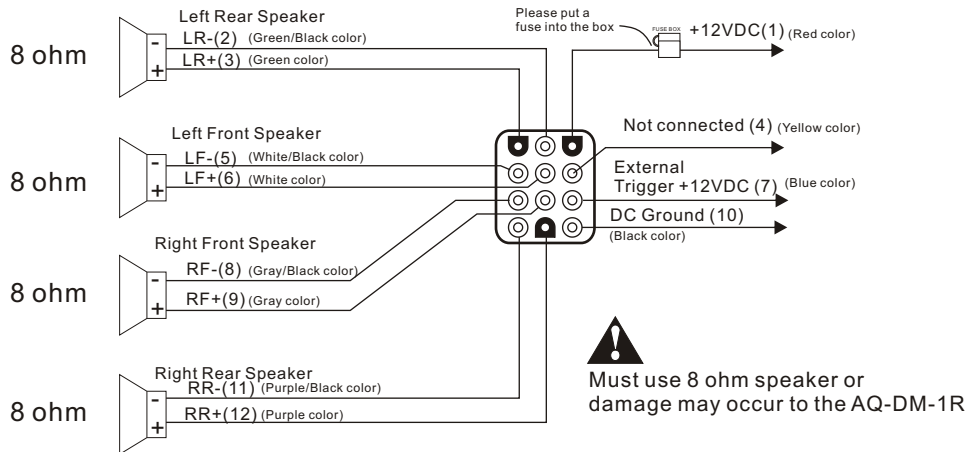

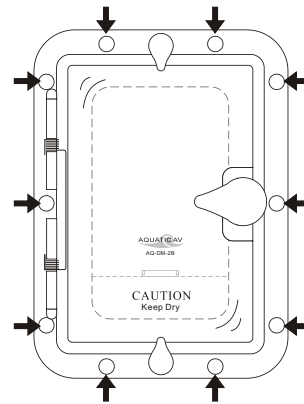

### Mounting the Unit

1. Mounting templates are included. Aquatic AV recommends to utilize the "measure twice, cut once" Method.
2. Once the mounting hole is complete, make sure the outside surface is clear of debris. The AQ-DM-2 has an external water/dust proof gasket, but it needs a clean surface for best performance.
3. The AQ-DM-2 has ten (10) front wood screws. Drive the 10 pcs of screws with a screw driver. During final mounting, apply equal pressure to all points for best water/dust outer seal performance.
4. Review all outside surfaces of the AQ-DM-2 to insure proper water/dust seal. This is important for the long term environmental protection performance for iPod or MP3 devices.
5. After the installation is complete, install the finishing covers over the stainless screws with silicone. We recommend a marine grade silicone as an adhesive.





## LISTENING TO PLAYERS

### Listening to iPod™:

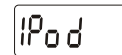
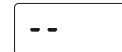
1. Power up the Digital Media Locker™.
2. Take Plastic cover off 30 pin connector and replace when not in use. .
3. Attach your iPod™ device to the iPod™ 30 pin connector.
4. Secure the iPod™ device with the anchor straps provided.
5. Secure the digital media locker™ water/dust protective door.
6. Press and hold  (POWER) on the remote control to turn it ON. The LCD will show "--" as shown on the right.
7. Press  (MUSIC) on the remote control to change to Music Mode. Use below buttons for the features.





Button	Press once	Press and Hold
	Last Track	Fast Rewind
	Toggle Play and Pause	Fast Forwarding
	Next Track	Turn iPod™ Sleep

### Listening to MP3

1. Power up the Digital Media Locker™.
2. Attach the MP3 device to the 3.5mm connector.
3. Secure the MP3 with anchor straps provided.
4. Secure the Digital Media Locker™ water/dust protective door.
5. RF Wireless remote Control of Volume only.

### Adjusting Volume Level

1. Press  (VOLUME UP) once to increase the volume by 3 decibels.
2. Press  (VOLUME DOWN) once to reduce the volume by 3 decibels.
3. Press and hold either UP or DOWN and the Digital Media Locker™ will increase or decrease audio volume continuously.

**i** If you are listening iPod™ and you change your mode to Radio or standby mode, the iPod™ will automatically turned OFF. The Charging screen will appear.

## LISTENING TO FM RADIO

### Radio Mode

FM radio is only available when you are in the FM Radio Mode.

#### To Enter FM Radio Mode:

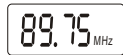



1. Press **FM** (FM RADIO) on remote control to change to FM radio mode. If this is the first time you listen to FM radio, the frequency will be 88.1MHz as a default as shown on the remote LCD. 

#### To Scan or Navigate Channels:



1. Press **◀** (FAST REWIND) or **▶** (FAST FORWARD) change channel in increments of 50kHz.
2. Press and hold either **◀** (FAST REWIND) or **▶** (FAST FORWARD) will scan forward or back for the next station. A "Scan" will appear on the LCD. 

#### Saving Radio Channel to Memory

If you want to save the current frequency into memory.

1. Press **MEM** (MEMORY) once to toggle to memory mode. 
2. Press **M+** (MEMORY +) or **M-** (MEMORY-) to change the location of memory.   

3. Press and hold **MEM** (MEMORY) to save the previous shown frequency to the location. 
4. Press **MEM** (MEMORY) once to toggle to manual mode. 

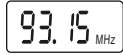
#### Listening Saved Radio Memory

1. Press **MEM** (MEMORY) once to toggle to memory mode. 
2. Press **M+** (MEMORY+) or **M-** (MEMORY-) to change the location of memory. 
3. Press **MEM** (MEMORY) once to toggle to manual mode. 



## OTHER FEATURES

### External Trigger

Aquatic AV understands the need for more flexible remote applications. With the Digital Media Locker, Aquatic AV has provided an independent 12V "accessory" trigger, activated by the RF Wireless Remote that provides user to activate non-iPod, MP3 related devices. This could include any 12V based devices like 12V lights or surveillance camera.

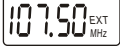
1. In any operational mode, press the lightning bolt  (12V TRIGGER) key to activate. Press again to deactivate. 
2. We strongly recommend you to speak with our tech service staff or your dealer if you're are considering to activate this feature.



**Load on External Trigger should not exceed 300mA.**

### Amplifier Sleep Mode

The Digital Media Locker's™ power amplifier will automatically go into "Sleep" mode in about 5 minutes of no audio sensing. For applications with the 12V independent battery operation, this will extend the battery life. Maximum power drain during "Sleep Mode" is 10mA.

### iPod™ Charging

When specified iPod™ devices are connected to the AQ-DM-1R 30 pin connector, iPod™ battery will charge.

To avoid rusting as a result of electrical potential in the connector, the battery of your iPod™ devices must not be totally drained. If your iPod™ is not charged at all then the unit will not charge it.

### Remote Control LCD Auto OFF

To maximize battery life of the RF Wireless Remote Control, the LCD of the RF Wireless Control remote will be OFF if no key is pressed in 10 seconds. To re-activate the LCD display, press  (POWER) once to bring the remote control to normal operation.

## iPod™ Cradles and Replacing iPod 30pin Connectors

### iPod™ Cradles

There are 5 cradles included for docking below iPods™:

- ① iPod™ classic 160GB;  
iPod™ 5G 60GB, 80GB



- ② iPod™ nano 3G, 4GB, 8GB

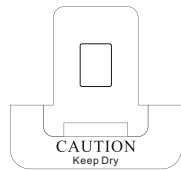

- ④ iPod™ touch 8GB, 16GB

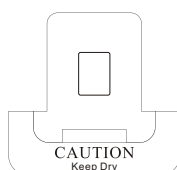

- ③ iPod™ classic 80GB;  
iPod™ 5G 30GB

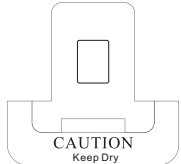

- ⑤ iPhone

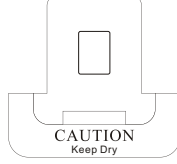

### iPod™ 30 pin Connector Replacement

Under harsh operation conditions, the iPod™ 30pin Connector may deteriorate. To ensure best performance, you can buy a new iPod™ 30pin Connector for replacing the deteriorated 30pin connector.

 Inspect the 30pin iPod™ connector for deterioration, water, rust, or damaged terminals before each use frequently to avoid operational problems or damage to the iPod™. Check the connector each time before inserting the iPod™. Always Replace the 30 pin connector cover after every use.

Follow below steps to change for the 30pin connector.

1. Pull out the cradle.
2. Unscrew the two (2) mounting screws.
3. Pull out the iPod™ 30pin connector.
4. Replace the new one.
5. Replace the cradle.

 Order iPod™ connectors (408) 559-1668 or a local dealer

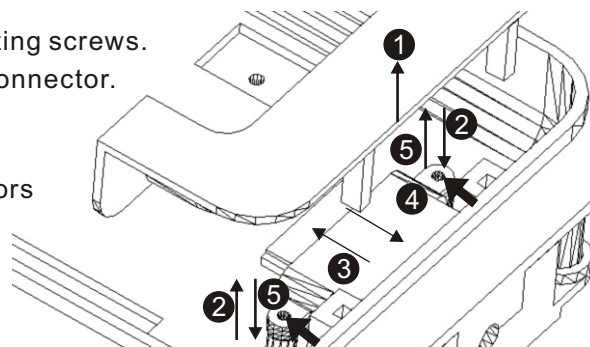

## SPECIFICATION

### Technical Specification

#### **General**

Power Supply	: 12V 5A min.
Current drain when OFF	: <1mA
Current drain in Standby Mode	: <10mA
Remote Control Frequency	: 2.4GHz
Remote Control Battery	: 3.0V (1 pc CR3123)
External Trigger	: 12.0V, 300mA max.
IP Rating	: IP66
UV	: 500 hours of UV without degradation
Remote Water/Dust Rating	: IP66

#### **FM Radio**

FM Radio Sensitivity	: 8uV
FM antenna	: Dipole Antenna (not included)
FM Radio Reception	: Stereo
Number of Preset	: 6

#### **Digital Amplifier**

Distortion	: <0.1% THD at 1kHz
Frequency Response	: 20Hz - 20kHz
Auto Amplifier Standby Mode	: 5 minutes +/- 10 seconds
Digital Amplifier Output	: 50W rms per channel at 4 Ohm load.

iPod™ is a trademark of Apple Computer, Inc., registered in the U.S. and other countries.

## FCC STATEMENT

FCC ID: WBQAQPAVRFMPIP  
MADE IN CHINA

This device complies with Part 15 of the FCC Rules. Operation is subject to the following two conditions: (1) this device may not cause harmful interference, and (2) this device must accept any interference received, including interference that may cause undesired operation.

**NOTE:**

This equipment has been tested and found to comply with the limits for a Class B digital device, pursuant to Part 15 of the FCC Rules. These limits are designed to provide reasonable protection against harmful interference in a residential installation. This equipment generates, uses and can radiate radio frequency energy and, if not installed and used in accordance with the instructions, may cause harmful interference to radio communications. However, there is no guarantee that interference will not occur in a particular installation.

If this equipment does cause harmful interference to radio or television reception, which can be determined by turning the equipment off and on, the user is encouraged to try to correct the interference by one or more of the following measures:

- Reorient or relocate the receiving antenna.
- Increase the separation between the equipment and receiver.
- Connect the equipment into an outlet on a circuit different from that to which the receiver is connected.
- Consult the dealer or an experienced radio/TV technician for help.

The manufacturer is not responsible for any radio or TV interference caused by unauthorized modifications to this equipment. Such modifications could void the user authority to operate the equipment.